

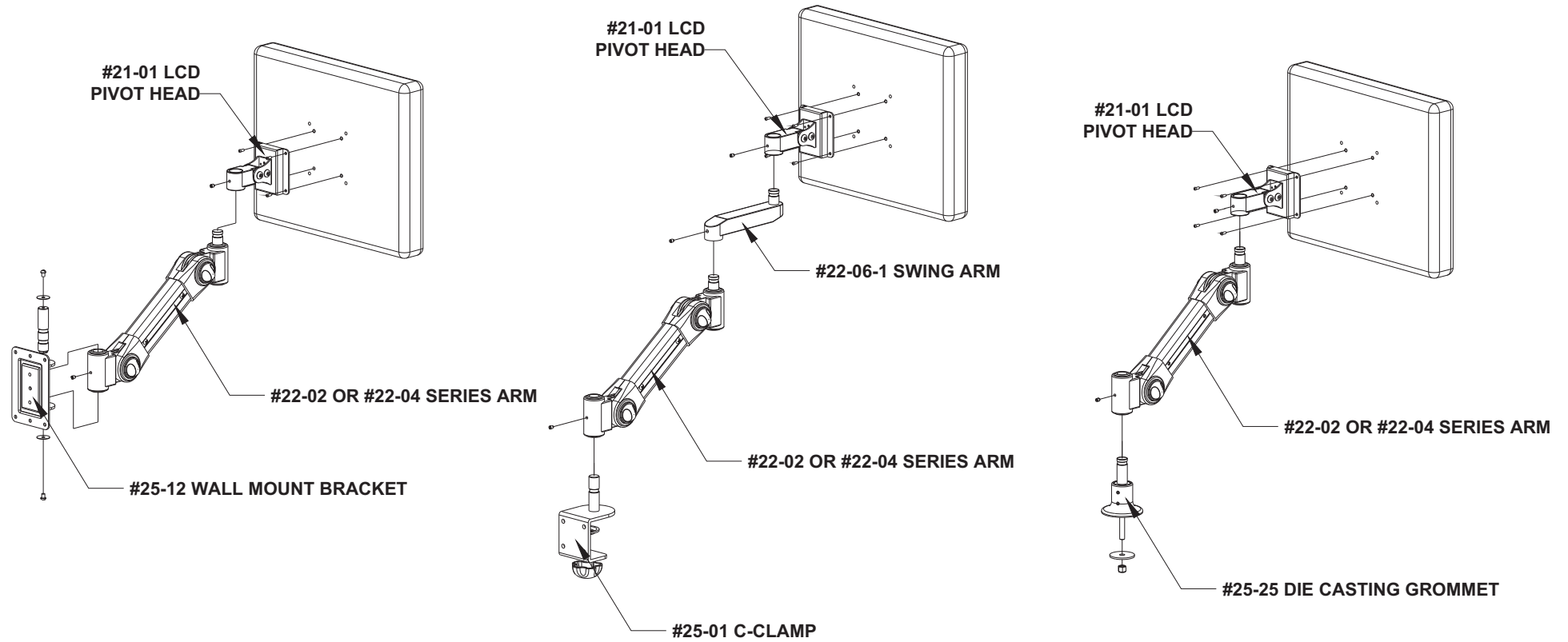
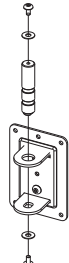

# #60210/#60212/#60220 SERIES LCD ADJUSTABLE ARM INSTALLATION GUIDE

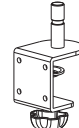
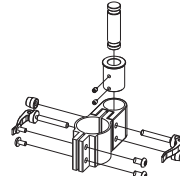
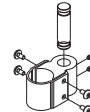
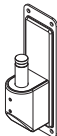

<p>#25-22</p> 	<p>#25-25</p> 	<p>#25-12</p> 	<p>#25-01</p> 	<p>#25-40/#25-42 series pole clamp</p> 	<p>#25-44/#25-45 pole clamp</p> 	<p>#25-15 die casting wall mount</p> 
---	---	---	---	--	---	--